

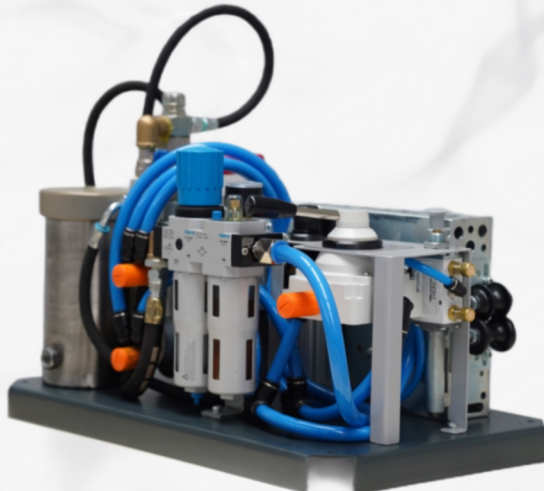

CONTACTS FOR MAINTENANCE
AND MANUFACTURING

Adress: Karadenizliler Mah. Işıklı Sok. No:3
Başiskele / KOCAELİ
Telefon: 0090 262 335 24 00
Mail: info@kosmak.com
Fax: 0090 262 335 24 15
www.kosmak.com

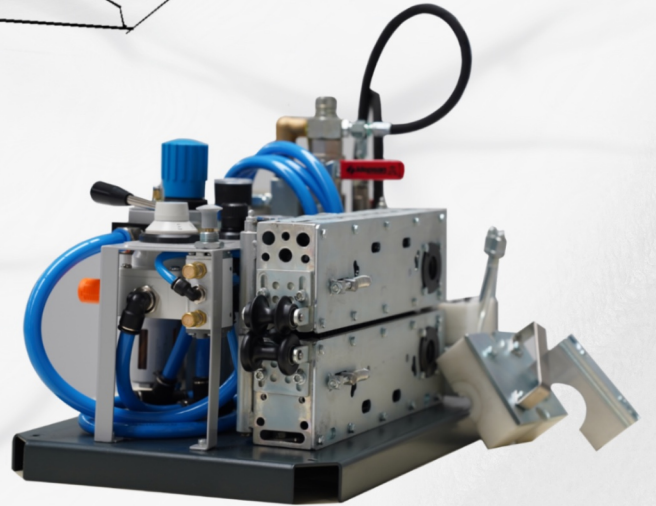

Fok

FOK FIBER OPTIC BLOWING MACHINE

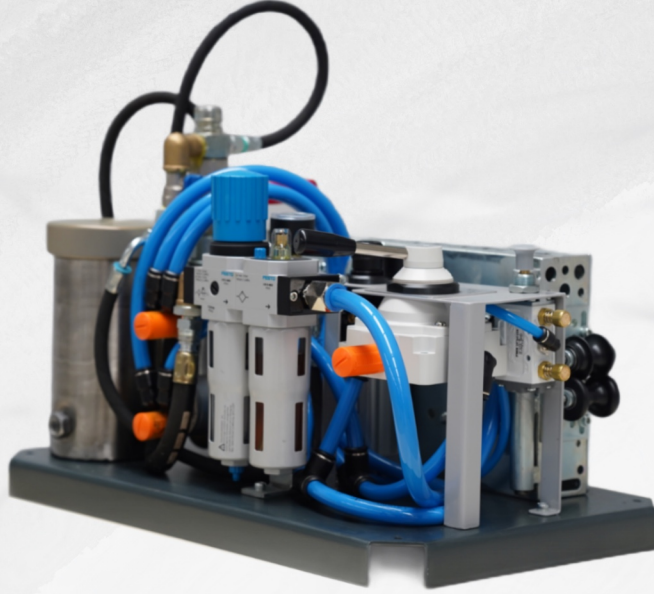

KÖSMAK MACHINE HISTORY

Our company has been in the machinery and machinery spare parts manufacturing sector since 1994. Since 1999, almost all of the fiber cable blowing works in Turkey have been done using fiber optic cable blowing machines produced by KÖSMAK MAKİNA. It continues its R&D activities on fiber blowing machines and revisions are made according to customer requests.

Fiber optic cable blowing machines produced by Kösmak Makina are used in many countries of the world, especially in Italy, the Netherlands, Uruguay, Holland, Germany, England, African Countries, Canada, USA, Syria, Iraq, Romain, Bulgaria, Kazakhstan, Libya and Suudi Arabia.

OUR UNDERSTANDING OF QUALITY

Based on the principle of customer satisfaction first, our focus is to fully perceive customer demands and expectations and provide complete products and services accordingly,

To achieve this goal;

- Continuously improving product quality, reducing costs while increasing product qualities, -To fully meet technological infrastructure and personnel information needs,
- Aiming for continuous improvement as a whole with the participation of employees.

OUR MISSION

To be the first choice of our customers with our products, solutions, after-sales services, reliability and high business ethics.

OUR VISION

To be a leader in its country and a preferred company in the world with its organization that that makes makes a name for itself in the technological developments in the sector in which it produces products and services, adds value to the lives of its customers and the society in which it operates, is admired for its performance in the solution partnerships it establishes with its customers, and adopts sustainable development as its working culture.

THE UNITS FOK MACHINE

The problems on ex air mouth (hook and but joint) are solved with this quick air connection design.

You can install your cable in muddy fields with our special designed palettes. Cable blowing power will not decrease.

Pneumatic press system don't let cable to skid and damage.

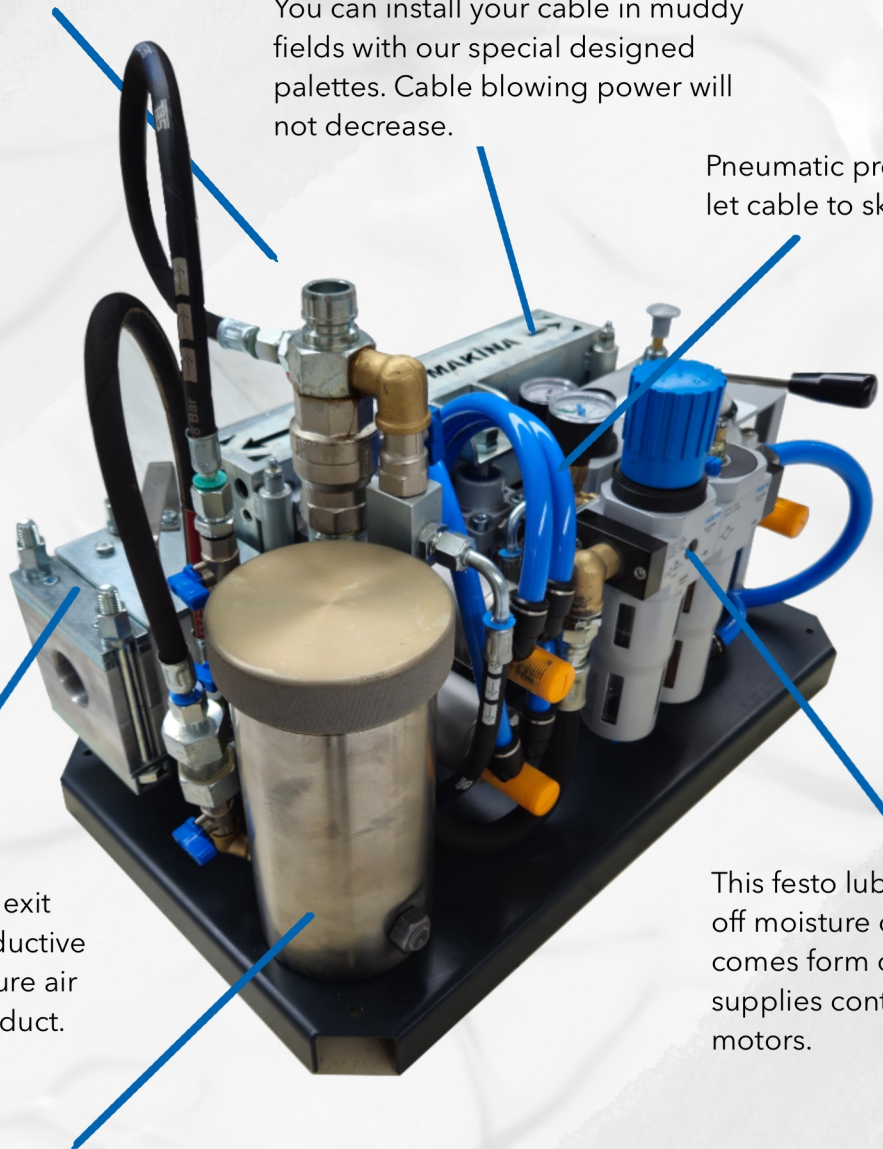

Special designed exit box supplies productive guiding for pressure air into pre-installed duct.

This festo lubricant system takes off moisture of pressured air which comes form compressor and supplies continous lubricate for air motors.

You can transfer oil (Lubricom-f) into pre-installed duct with this shock lubrication system to reduce friction between duct and cable.

FOK

FOK Cable Blowing Machine provides an excellent flexibility and compact design to the users offering a complete solution. Capable of installing the cables Fiber optic cable and micro duct. In a range of 9 to 22 mm diameter and duct outer diameter (OD) may vary 20 mm to 50 mm. FOK Machine is engineered for blowing Fiber optic cables in preinstalled ducts. This multifunctional machine is easy to use for the installation of cables and micro-ducts by air and covers a wide range of cable diameters.

Fok Machine has a significant productivity and it considerably increases your labor's production capacity. A special and carefully designed pallet system assuring an excellent cable drip and decrease the damage risk. Clamping system adjust the cable outer diameter fluctuation/tolerance. In addition to that, its high-tech engineered and produced to meet and exceed the expectation of customer requirements.

FOK Machine is a Fiber optic cable blowing machine designed to blow cables into preinstalled telecommunication ducts and micro ducts by using of compressed air. Having 3 pallet options as 9-14 mm, 14-18 mm and 18-22 mm to blow the cables having min 9mm to max. 22 mm with a speed of 80 m/min. Duct diameter can be in the range of 20 mm to 50 mm. Special pallet design will allow you to install your cables under muddy field conditions and Cable Blowing Power will not be decreased. You can set cable installing speed and direction with control valve.

A wisely designed exit box will supply highly productive leading for pressured air into telecom ducts. Quick air connection makes your business easier with an easy plug-in method. You can transfer lubricant oil onto pre-installed duct with the shock lubrication system to reduce friction between duct and cables. Two air motors will ensure to continuous high effective cable blowing power. You are capable of switching on or off the air entering into telecom ducts with guidance of valves. Festo Lubricant system takes off moisture of pressured air which comes from compressor and supplies continuous lubricate for air motors.

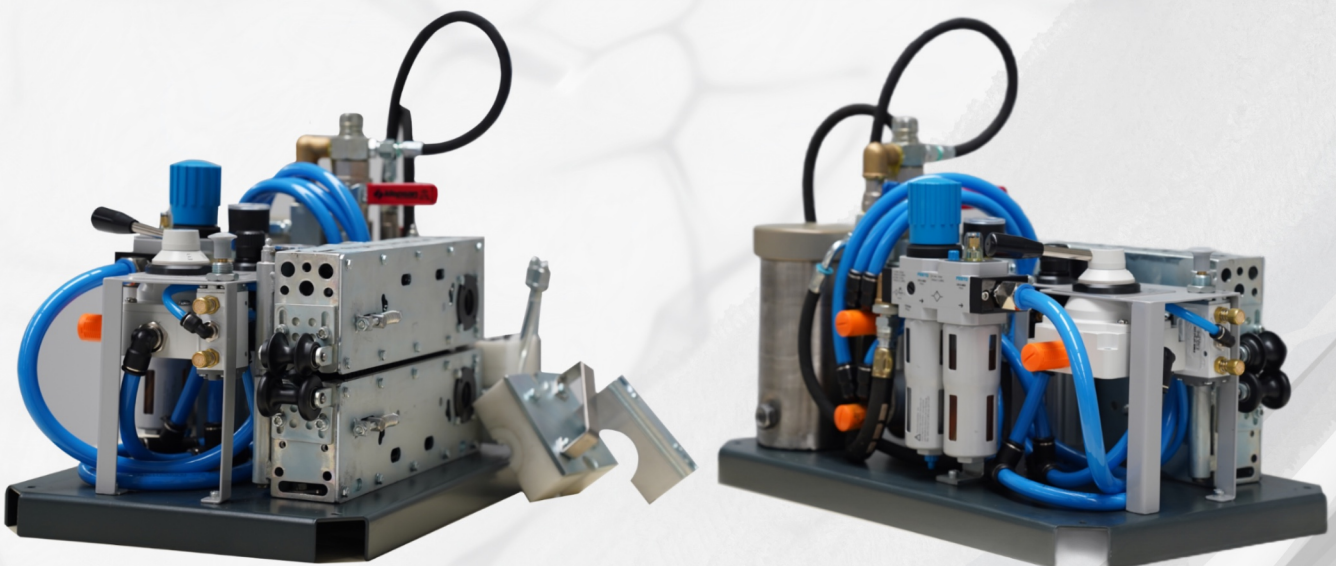

FOK CONTENT

INCLUDING WITH MACHINE

1 set (2pct) of Pallet (1)	1 pcs Operator Guide (6)	1 pcs Protected Wooden Case with holder (11)
1 pcs Duct Lubricant System (2)	1 pcs Cable Inserts (7)	1 pcs Quick Insert Air Jack (12)
2 pcs Air Motor (3)	1 set Duct Inserts (8)	1 set Tool Kit (13)
1 pcs Air Lubrication System (4)	1 set Blue Nutring (9)	1 pcs Box for plastic tools
1 set Cable Aligning Paris (5)	2m Black Rubber O-Ring (10)	

NOT INCLUDING WITH MACHINE

Air Cooler

Lubricant Oil

Air Compressor

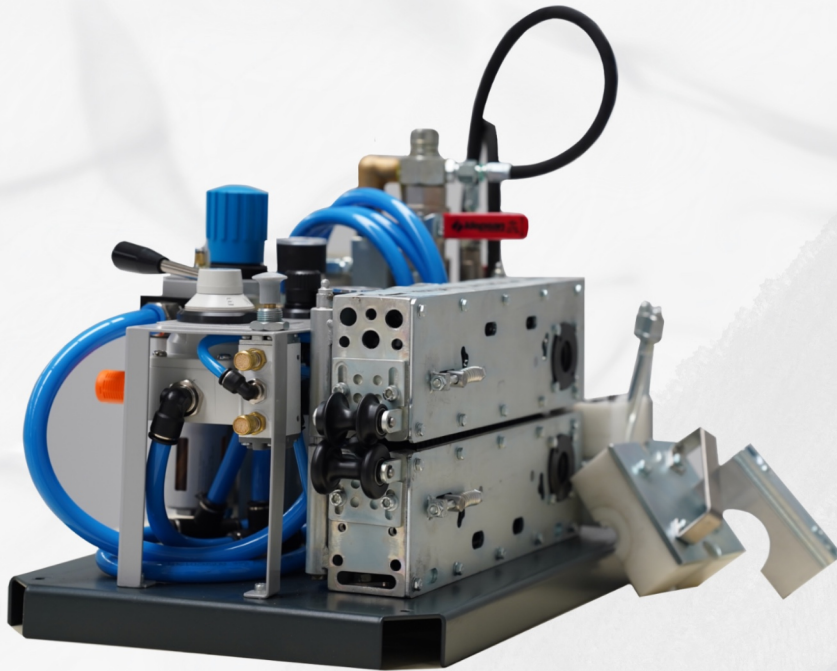

FOK

TECHNICAL DATA

Standart version	2 pcs of pneumatic motor drive
Type	FOK
Cable dia. [mm]	9-22
Pallet Options [mm]	9-13 / 14-18 / 19-22
Duct OD [mm]	20-50
Drive unit	Pneumatic
Max. air consumption of 2 pcs of motor [m ³ /min]	3m ³ / min (at 6 bar)
Torque Nm - Max. Power	8.5 Nm x 2 Pieces
Max. distance to blow at once (Cable Dia. 12 mm - Duct Dia. 40mm) (m)	3000
Max. speed [m/min]	80
Max. air pressure [bar]	16
Max. water pressure [bar]	23
Dimension of apparatus with case l x w x h [mm]	380 x 610 x 440
Weight of machine [kg]	40
Total weight [kg]	49

FOK MACHINE PARTS

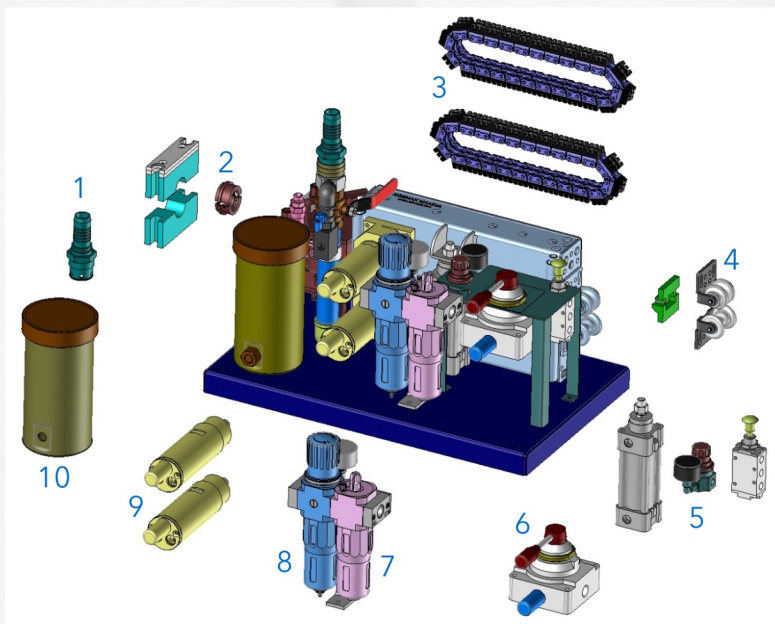

1-Quick Pipe Connection

2-Easy Duct Connection

3-Rubber coated chain for pushing cable without skidding

4-Cable aligning parts to blow cable ahead.

5-Pressure regulator with piston group to regulate pushing force on cable and to make up&down movement automatically

6-Direction control valve for pushing and pulling fiberoptic cable

7-Air lubricating unit to lubricate air motors during cable blowing

8-Pressure regulating unit to regulate air pressure on air motors

9-Two air motors pushing cable together

10-Duct lubrication unit to lubricate duct during cable blowing.

FOK

ACCESSORIES

COMPRESSOR CAPACITY RECOMMENDATION

Efficiency 10,5 m³/min

Working pressure 12 bar

These are minimum compressor requirements. You may use higher capacity of compressor which can increase the effectiveness. You can overcome the handicap of improperly installed ducts.

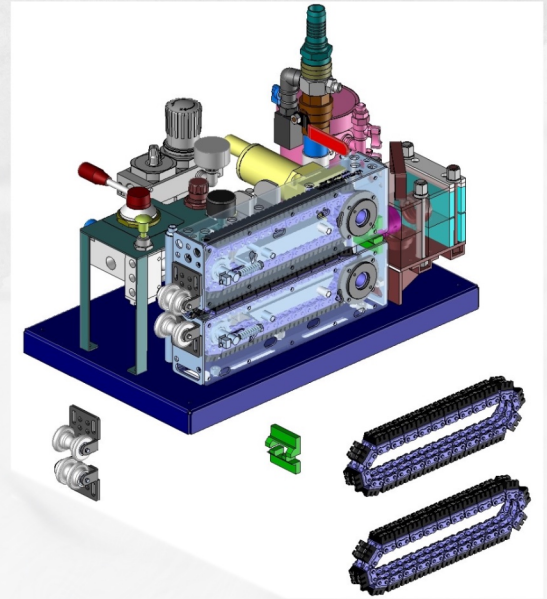

PALLET, CABLE ALIGNING AND DUCT OPTIONS

Pallet Set (mm)	Cable Aligning Tool & Nutrings (mm)	Duct Connection Tool (mm)
P1: 9-13	C1: 9-13	D: 20
P2: 14-18.	C2: 14-18	D: 32
P3: 19-22	C3: 19-22.	D: 40
		D: 50

ORDERING CODE

FOK	P1	C1	D1
Machine	Pallet Set	Cable Aligning Tool & Nutrings.	Duct Connection Tool
P2: 14-18.	P1	C1.	D10
P3: 19-22	P2	C2.	D20
	P3.	C3	D32
			D40
			D50

Multiple Ordering

Multiple Ordering

P1+2+3

D10+20+32

1 set of Pallet - 1 Set of Cable Aligning Tool + 1 pcs Duct Connection Tool is included

FIBER OPTIC CABLE BLOWING MACHINE USER'S BOOK

Selecting and locating cable seals

Setting axis for cable diameter

Preparing pulleys

Locating pre-installed duct and cable

Making air connections coming from air compressor

Pressure gauges, pressure values and setting pressures

Using shock lubricant

Using direction control valve

Using palette control valve

FOK maintenance instructions

Safety rules

Transporting machine

Correction of faults

Tools given with machine

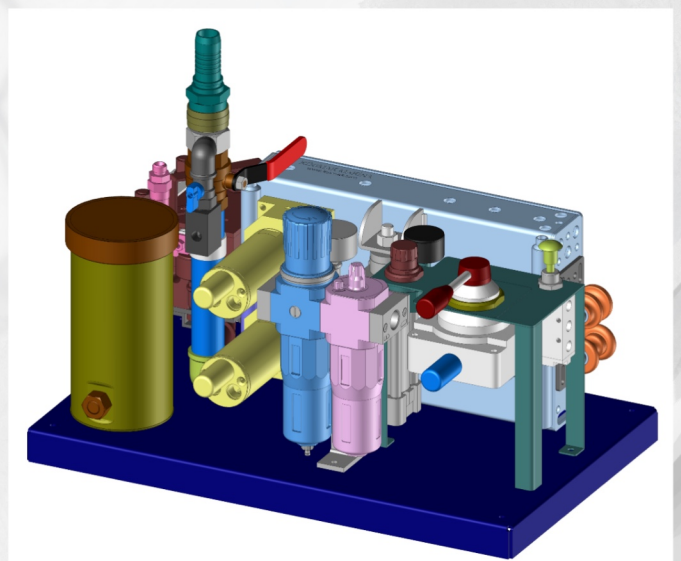
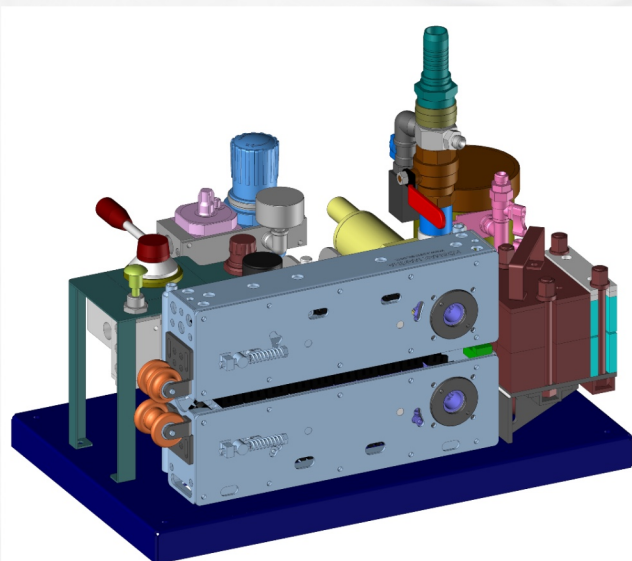

SELECTING AND LOCATING CABLE SEALS



Figure 1

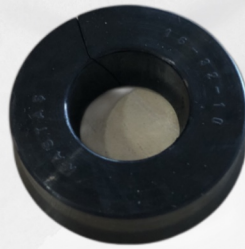

Figure 2



Figure 3

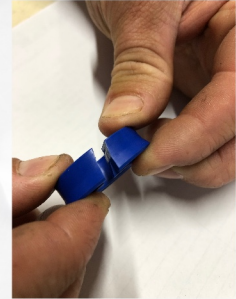

Figure 4

Firstly measure cable diameter with callipers (figure 1). The selected cable seals inside diameter (figure 2) must be same with cables outside diameter and it must work slippery on cable (figure 3) not to let air leak. Cut cable seals as you see on figure 4.



Figure 5

Note: You must inform us your cable diameter that you will install with your FOK order.

Canals of the selected cable seals must locate to install way of cable. If not, we can not use compressed air productive which comes from compressor (figure 5).

Touch faces of black o-rings with cable seals must be cutted angular (figure 5-2)

SETTING AXIS CABLE DIAMETER

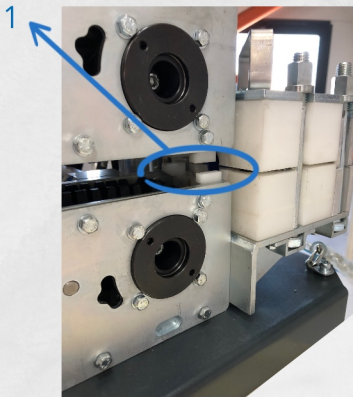

Figure 6-a

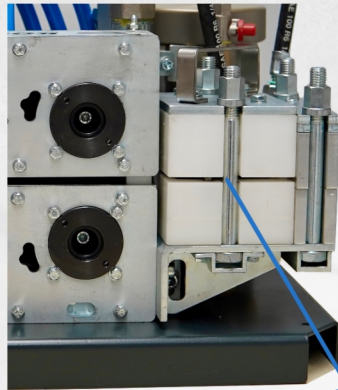

Figure 6-b



Figure 6-d

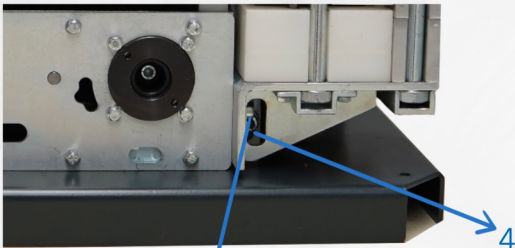

Figure 6-c

Axis of the machine must be set, when the cable diameter is changed to make productive blowing. Locate the cable you will blow into machine as seen on figure 6-a to set axis. (Number 3,4 and 5) and set on same level cable axis on machine (no:1) with touch face (No:2) between up and down exit box parts. Then setting axis press bolts (3, 4, 5 numbers on figure 6-c/6-d) to fix axis for your cable.

Note: If you inform our company about your cable diameter before you buy machine, machine axis will be set by our company. When you will blow different cable diameter, you will have to set axis as we explained up wrench set will be given with machine.

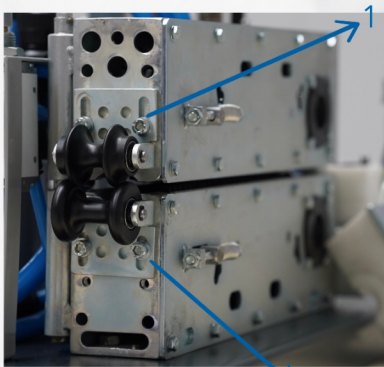

Figure 7

PREPARING PULLEYS

Pulleys on figure enable the cable to go into the machine on axis easily. Pulley's distance is set by bolts. (No.1,2 on figure 7) For cable diameter. Pulley's distance must be closed if not, cable can get out from sides and break.

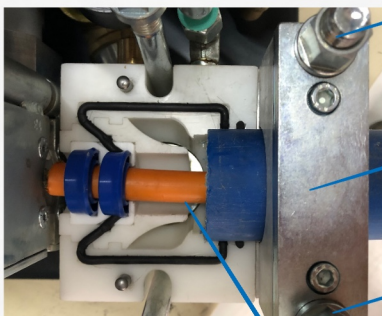

Figure 8

LOCATING PRE-INSTALLED DUCT AND CABLE

Loosen bolts (No. 2,3 on figure 8) firstly to assemble Duct to machine and then leave the upper part (No:1) Drive duct until the face number 4. Then put the upper part (No:1) on cable and press bolts (No:2,3) to finish duct assemble Locate cable into machine as shown on figure 8.

Note: Selecting cables, setting cable axis, preparing pulleys are done when the cable diameter is changed.

MAKING AIR CONNECTIONS COMING FROM AIR COMPRESSOR



Figure 9-a

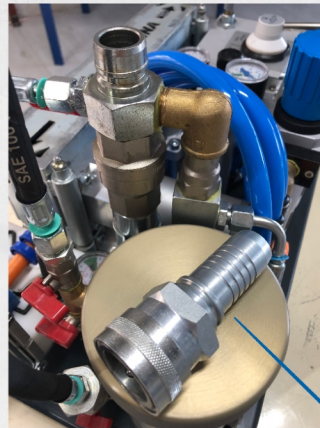

Figure 9-b



Figure 9-c

Connect 1" air hose to machine with quick connection which comes from air compressor. Quick connection sin body is assembled on machine as you see figure on 9-a-1. Quick connection moving part is given with machine as you see in figure 9-a-2. Assemble quick connection moving part to the machine as you see in figure 9-b. Connect air hose to the part 3 in figure 9-b. Tren assemble parts as you see in figure 9-c.

PRESSURE GAUGES, PRESSURE VALUES AND SETTING PRESSURES

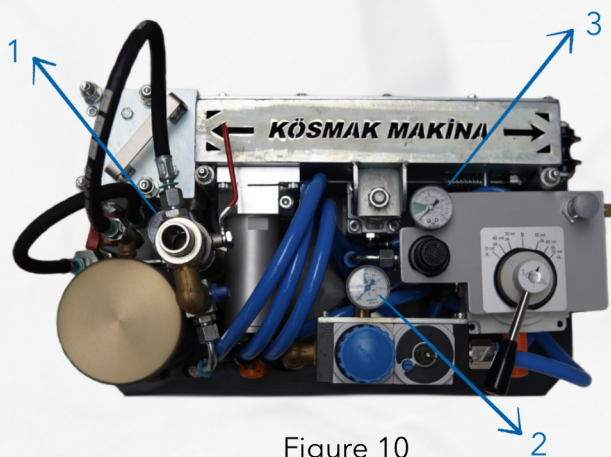

Figure 10

1-) **Duct Pressure Valve:** Duct blown in world standards must have minimum 10.5 bar (You must see this value on gauge shown in figure 10-1) to blow your cable. If not, you can't blow your cable.

2-) **Air Motor Pressure:** You must see 6.5-7 bar on gauge figure (10-2) when you are blowing. If you work on higher values this will cause your motor pulleys to be damaged and your air motors will break down.

3-) **Pallettes Pressure Value:** Pneumatic piston supplies pallette pressure. This system prevents the wear on your cable between pallettes. You must set this pressure value with checking weather conditions. Your cable mustn't skid between pallettes in normal conditions this value range must be between 2-4 bars.

Note: Setting air engine pressure and pallette pressure is explained on the next page. There is no pressure setting for DUCT.

SETTING PALETTE PRESSURE



Figure 11

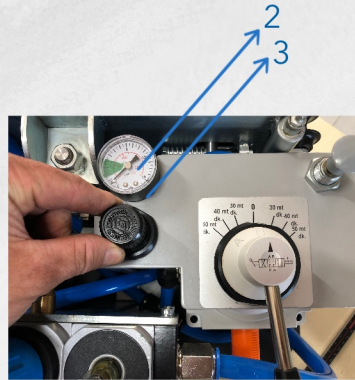

Figure 12

You can set piston pressure (figure 11-1) on palletes with using regulator (figure 12-2) and you can control pressure on gauge (figure 12-3). Do not increase pressure value too much if you increase it you candamage your cable and air motors.

SETTING AIR MOTOR PRESSURE LUBRICATION STYLE



Figure 13

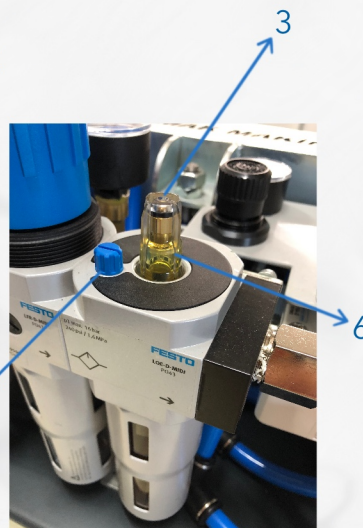

Figure 14

Use the mechanism (figure 13-1) to set pressure of air motors and control on qauge (figure 13-2). Air motors must work between 6.5-7 bar.

The reservoir (figure 13-4) takes moisture of pressurized air which comes from compressor. Use tap (figure 15-1) to discharge collected moisture. You must do this operation not to let rust the parts of air motors.

Put oil for air motors to reservoir (figure 13-5). And use screw (figure 15-2) to re-fill it. This is necessary to lubricate bearings of air motors.

When the blue stopper opened (figure 14-7) lubrication for air motors will be closed.

Use screwdriver (figure 14-3) to set the amont of oil for air motors. Current amount of oil is one drop in one minute. You can see drop in (figure 14-6)



Figure 15

Note: Our FOK is ready to install cable after making the configurations we stated as number 1,2,3,4,5,6 in earliner pages. We can start to install our cable by using direction control valve.

USING SHOCK LUBRICANT



Figure 16

To reduce friction between cable and duct put special oil (lubricant) into reservoir (figure 16-1-1). You may see the closed position for lubricant valves on figure 16-2. To let oil into duct open valve figure (16-2-2) then open-close valve in a short time (figure 16-3-3). This quick open-close move will oil into duct.

You may check duct lubricant from indicator (figure 16-3-6) to re-fill reservoir, open valve (figure 16-1-4) and discharge pressurized air. Then this discharge close valve. Then open reservoir lid. (figure 16-1-5) and put lubricant oil and close lid again tightly until there is no air leak.

USING DIRECTION CONTROL VALVE



Figure 17

You can regulate fibre optic cable direction and speed (0-60 m/min) by moving direction control valve to right or left.

Note: You must use stop position when you are changing the direction. If you pasa the opposite direction directly and don't stop on stop position this will damage the gears of air motors.

USING PALETTE CONTROL VALVE



2 Figure 18

Palettes can join or leave with buttons on figure 18-1 and figure 18/2. Push or pull buton on figure 18-2 while pushing button 18-1. You can set movement velocity of upper palletes by using valves on figure 18-3.

FOK MAINTENANCE INSTRUCTIONS

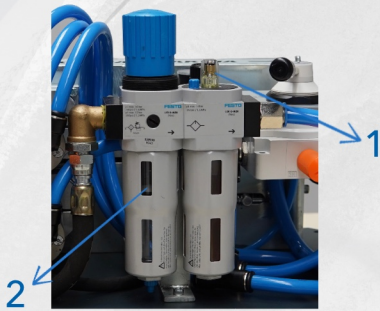

Figure 18

To maintain air motors, open oil set screw until end (figure 18-1) and run motors 30-35 secs on this position. This operation supplies bearing lubrication for air motors and parts.

This operation must be repeated in every evening after the work ends, if not the moisture collected in motors will cause the bearings to rust.

The foreign objects entering into reservoir (figure 18-2) causes to the filter be blocked. This changes its colour and its shape. You must change this filter before this case occurs, if not air pressure yield will be less and you will have problems about the machine.

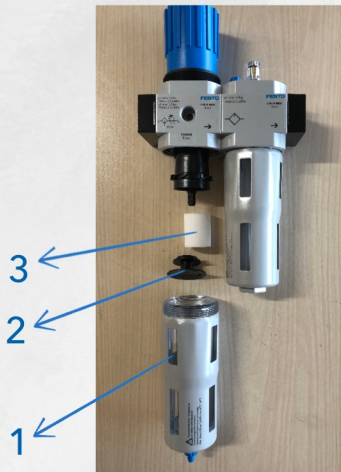

Figure 19

You can see the demontaging of air filter on 19. Firstly open reservoir (figure 19-1) and nut figure 19-2) then you can take air filter (figure 19-3).

Put our cable seals (figure 20-1) and o-rings (figure 20-2) to make care of exit box (figure 20). Clean their slots with diesel oil and brush. If cable seals and orings are beaten, change them otherwise there will be air leak.

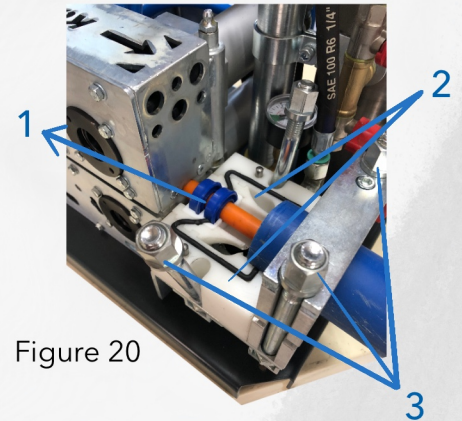

Figure 20

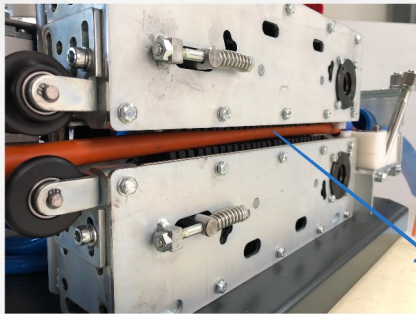

Figure 21

Locate your cable in to machine s shown in figure 22. Pallettes must press to cable and pallettes mustn't touch each other. If they touch, this means your pallettes are worn away. Pallettes must be changed.



Figure 22



Figure 23

If the blowing area is muddy, mud can go into the pallettes of the machine, you may clean mud with pressured water and using holes as you may see on figure 22 and 23.

SAFETY RULES



If there is something happens unusual on machine push emergency button to get out pressurised air from machine then machine then close compressor quickly.

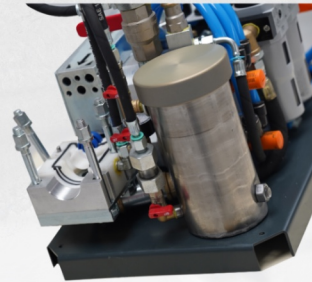

Do not open cover before evacuating air on box.

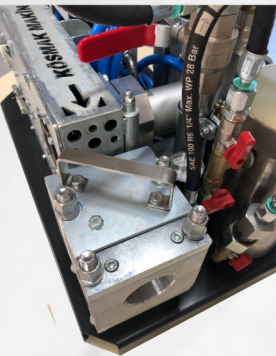

Close nuts correctly before giving air on machine. If nuts and bolts are beaten change them with new ones.

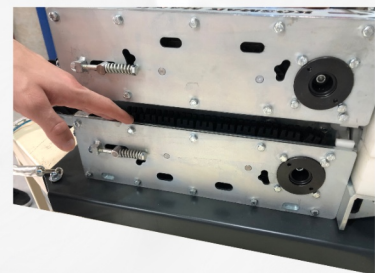

Work machine with only bright places do not touch working parts on machine. Use gloves and ear plugs while working with machine.



Figure 24

You must check quick connection before giving air to machine. Take up quick connection part as you see in figure 24 to check it. Do not use if it is coming up.



Do not open water tap and oil jar before evacuating air on machine.

TRANSPORTING MACHINE



Figure 25

After taking out in box. Carry cable blowing machine as on figure 25.



Figure 26

Carry cable blowing machine as on figure 26.

IMPOTAND NOTE: TAKE OUT AIR ON MACHINE BEFORE CARRING MACHINE.

CORRECTION OF FAULTS

If your machine can not catch cable and palettes skids on cable, it means that your palettes are damaged and needs to change or palette pressure is low. (Look 6/6A)

If cable exit box squeeze cable it means that cable seals are false chose correct cable seals. (Look 1)

If there is oil or air leaking on exit box palettes side it means that your cable seals are false or montaged false direction (Look1)

If there is air leaking on exit box, clean surfaces of exit box and change o-rings. (Look 1)

If you machine is working hardly while you are blowing cable, it means that your ducts air pressure can be less, you nede to increase your air pressure which is coming from compressor. It must be minimum 12 bar/10.5 metercup/minute. (Look 6)

If your cable blowing machine is working but you can not blow cable in ducts is means that your ducts can be plugged. You need to solve the problems in ducts. (Look 15-1)

If palettes of cable blowing machine is not turning it means that bearings are damaged because of slogging or bearing are rusted because of being in wet situation. You must send machine for maintenance.

If your air motor is not not turning it means that bearing of air motor are damaged you need to send machine to maintenance. (Look 6-b)

If your air motor is not not turning it means that gears are damaged you need to change gears. You must send machine for maintenance.

If your air pressure on motors are reducing while you are cable blowing it means that your air filter is plugged or damaged you need to change it. (Look 10)

TOOLS GIVEN WITH MACHINE

1) Socket wrench arm set ("T" arm)	1Qty
2) Socket wrech arm set mid part (Long: 25 cm)	1Qty
3) Socket wrench (16-13)	1Qty
4) Open-End wrenchs (8-9 / 10-11)	1Qty
5) Allen wrench (5mm / 6mm)	1Qty
6) Screw driver (3x80)	1Qty
7) Stationery knife	1Qty
8) Special air lubricant ail	1Qty
9) O-ring (Ø95x5)	1Qty
10) Ø 3,5 O-Ring 50 cm	1Qty
11) Ø 4 O-Ring 50 cm	1Qty
12) Ø 8 Air pipe 100 cm	1Qty
13) Ø 14 Air pipe 2 mt	1Qty
14) Ø 16 Air pipe 50 cm	1Qty

Note: We set axis line of FOK with the information of cable diameter before sending the machine. We send 10 pieces cable seals, 1 piece cable sesli slot and 3 pieces of felts with machine for your cable diameter. You can sele cable diameter groups under, but if you inform us your cable diameter this will be better.

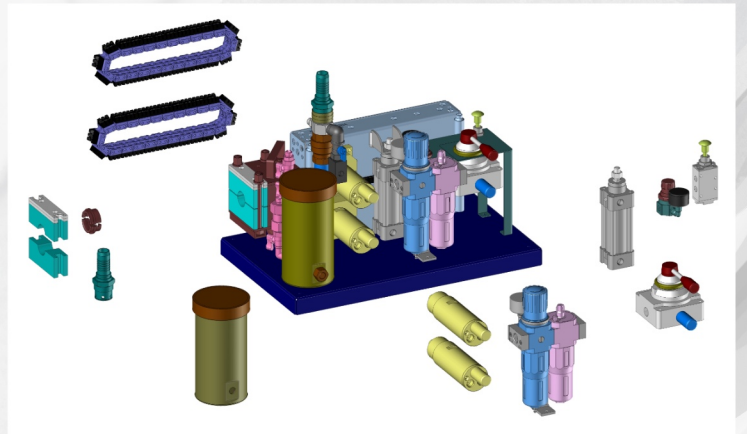
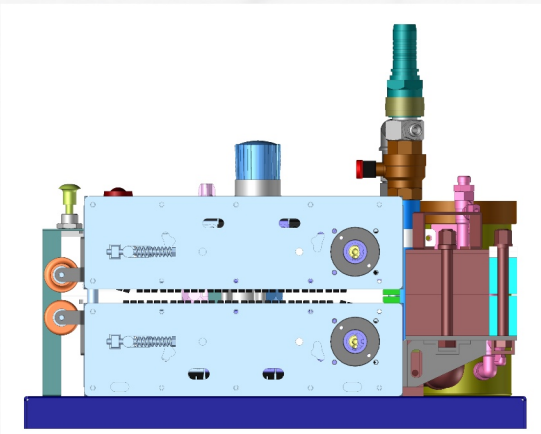

WORKING LAND TERMS

CONDITIONS FOR FIBRE OPTIC CABLE BLOWING MACHINE PRODUCED BY KOSMAK MACHINE BUILDING, INDUSTRY & TRADE CO. THAT YOU HAVE TO CHECK ON WORKING AREA BEFORE YOU START TO WORK.

1) DUCT CONTROL

USE NATURAL GAS PIPE (DIA:25 MM, LENGTH: 1.5 m) BOTH SIDE CLOSED THE CONTROL DUCT. THIS PIPE MUST PAS ALL ALONG IN YOUR DUCT.

2) MACHINE CONTROL

MONTAGE THE MACHINE TO PIPE AND LET PRESSURIZED AIR IN, AFTER YOU CHECKED THE SUITABILITY OF YOUR DUCT. WHEN PRESSURIZED AIR WENT OUR FROM THE END OF DUCT, YOU MUST SEE THESE VALUES:

AIR MOTOR PRESSURE: 6 BAR /// PISTON PRESSURE: 2-4 BAR /// DUCT PRESSURE: 10.5 BAR (MACHINE AXIS MUST BE SET TO RUN)

3) WORKING CONTROL

YOU MUST TRY TO STAY IN SAME LEVEL AS FAR AS POSSIBLE DUCT, MACHINE AND FIBRE OPTIC CABLE

YOU MUST HAVE THESE VALUES WHEN YOU ARE RUNNING MACHINE:

AIR MOTOR PRESSURE 6 BAR: /// PISTON PRESSURE: 2-4 BAR /// DUCT PRESSURE: 10-11 BAR.

CHECK OIL DROP VALUE THAT YOU NEED FOR AIR MOTORS ON AIR LUBRICANT (2-3 DROPS/MIN) YOU MUST DO SHOCK LUBRICATION IN EVERY 150 METRES YOU INSTALLED.

YOU MUST LEAVE INSIDE OF AIR MOTORS OILY AFTER YOU USE THE MACHINE, TO DO THIS: LOOSEN THE OIL SET SCREW ON PREPERATION AIR LUBRICANT AND INCREASE THE SPEED OF OIL FLOW AND RUN MACHINE 3-4 MINS THIS POSITION.



CONTACTS FOR MAINTNEANCE AND MANUFACTURING

Adress: Karadenizliler Mah. Işıklı Sok. No:3
Başiskele / KOCAELİ
Telefon: 0090 262 335 24 00
Mail: info@kosmak.com
Fax: 0090 262 335 24 15
www.kosmak.com